

HDO installation
Toyota Pro Ace - Verso.
Model 2022 version 1,2

Bracket kit IN008-8-BRA.



auto products

Included in kit:

HDO bracket.

Hatch door bracket.

1 pc relay. (Standard auto-relay)

9 pcs Threaded nuts.

16 pcs M8 X 20mm.

3 pcs M8 X 16mm

Finished installation.



Use bracket as template, see the position from the picture.

Drill holes and install threaded nuts.

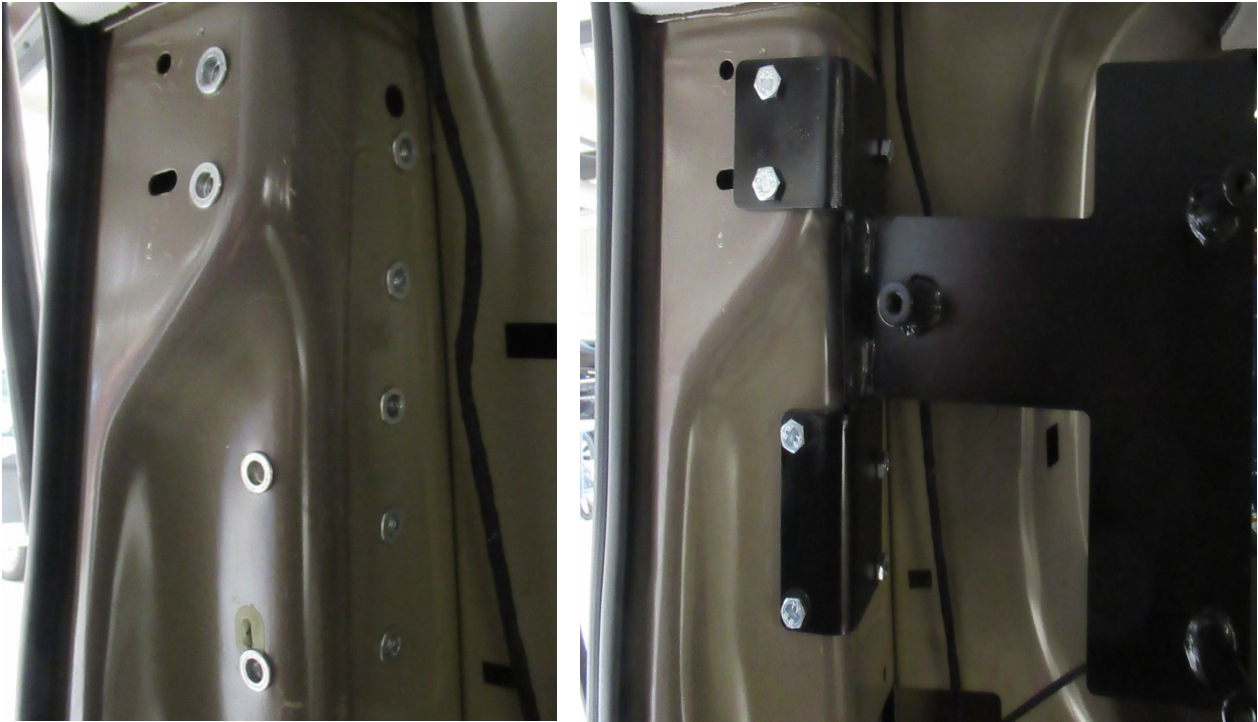

D-pillar is covered with fabric/flex carpet (Not included)

Only necessary in Proace **"verso"**





Original plastic cover (D-pillar) is modified + Special cover is made (Not included).

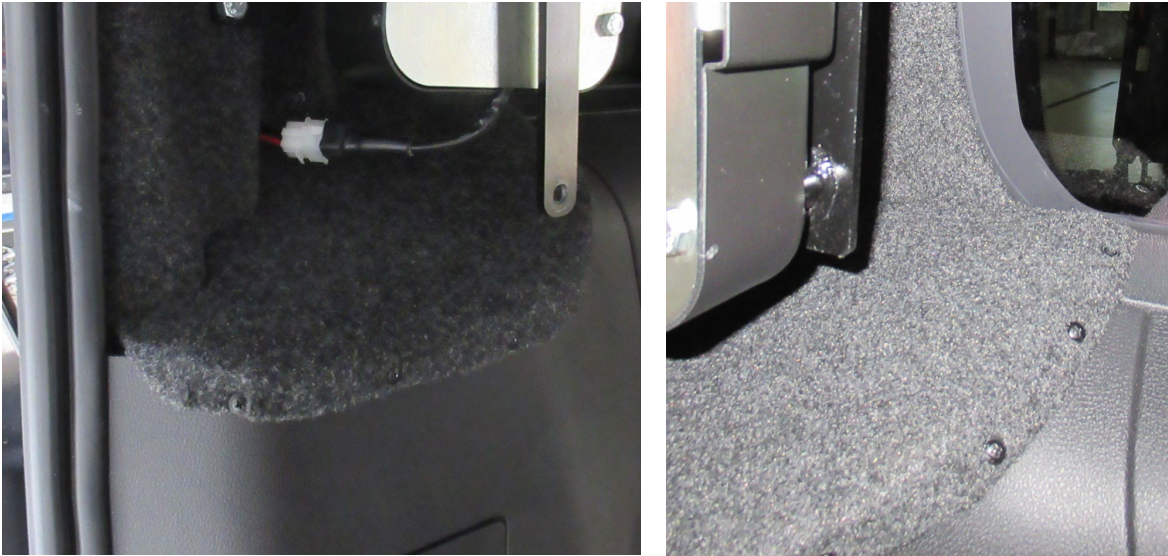

Hatch bracket is installed.

4 pcs Ø8 holes are drilled (Use bracket as drill model)

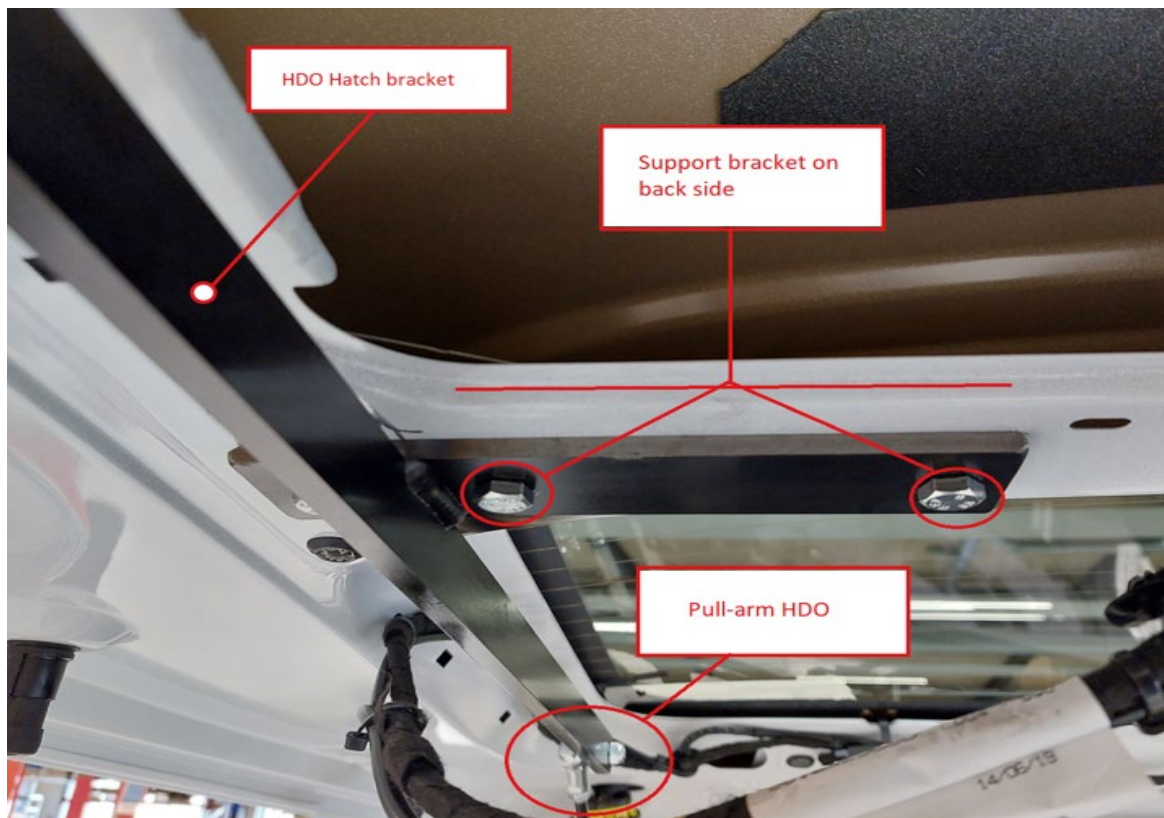

Support bracket

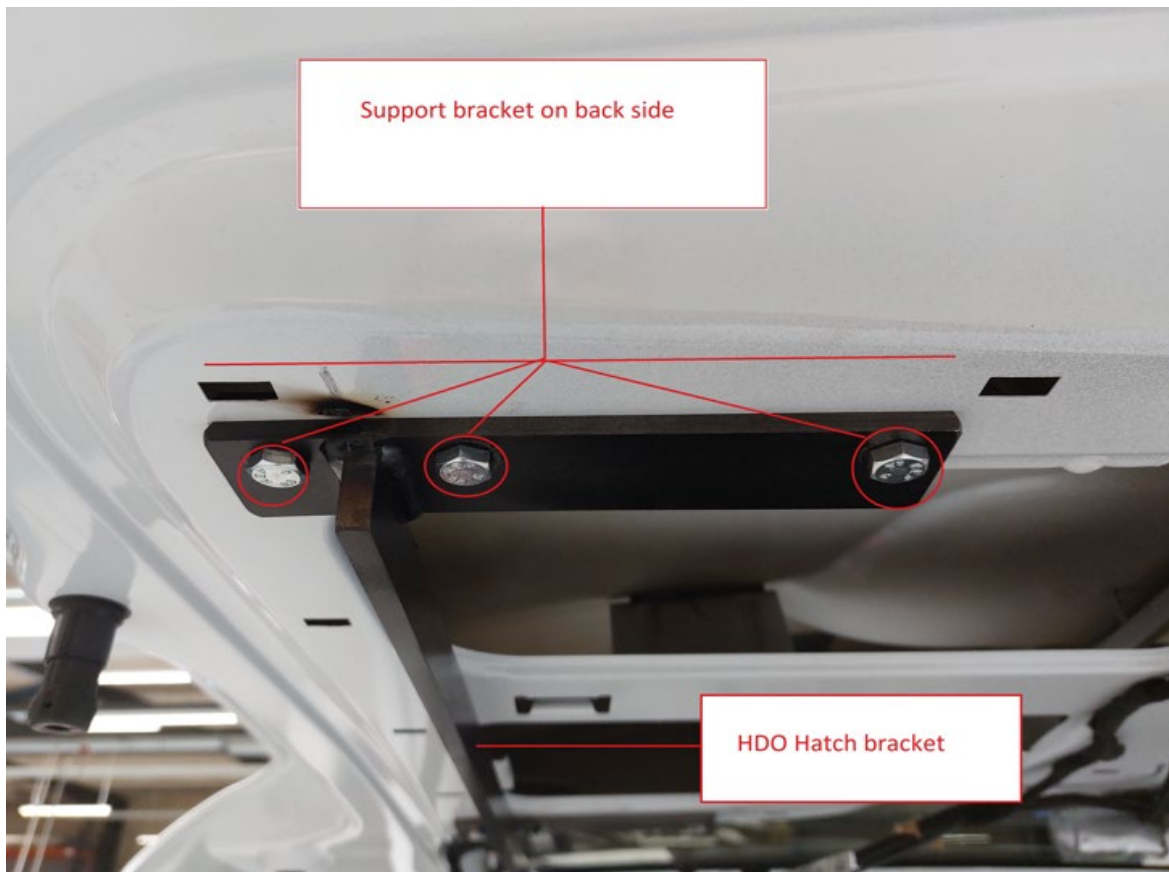

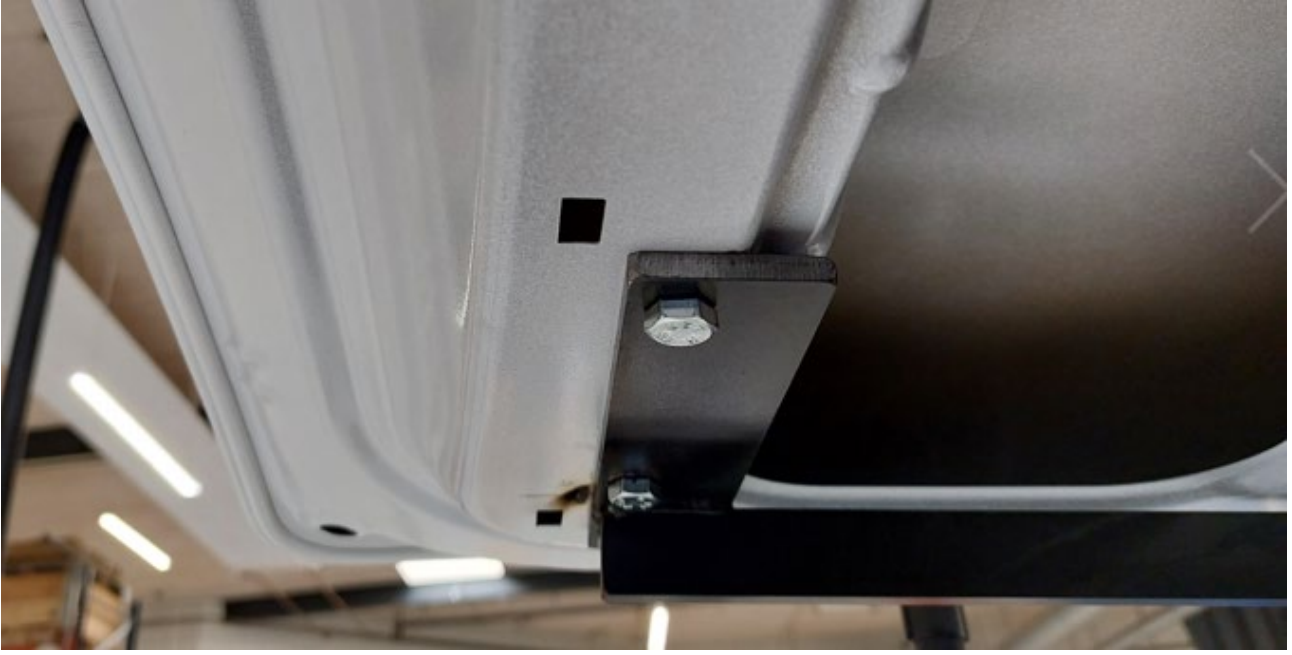



Cover modification hatch and pull arm installation



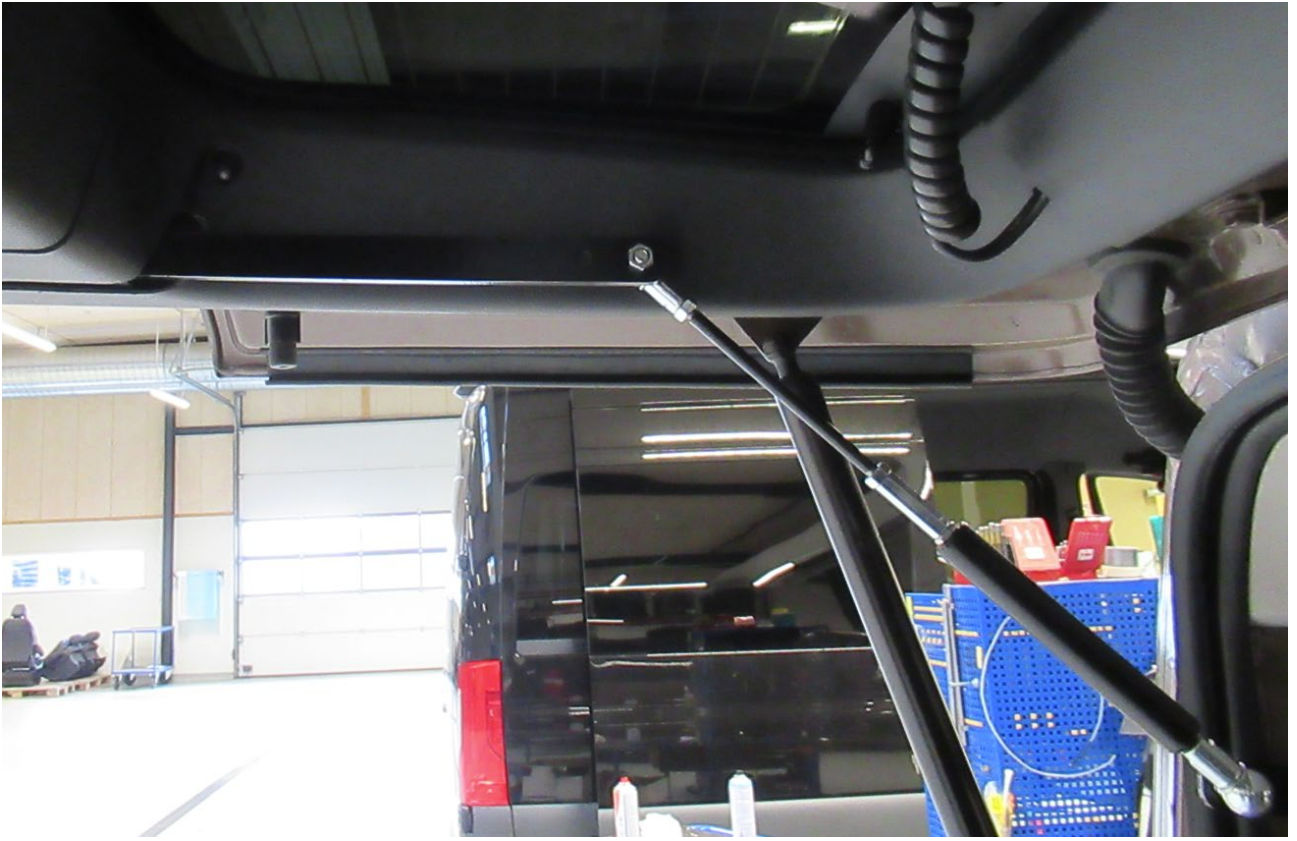

Toyota Pro-ace 2022- wiring diagram

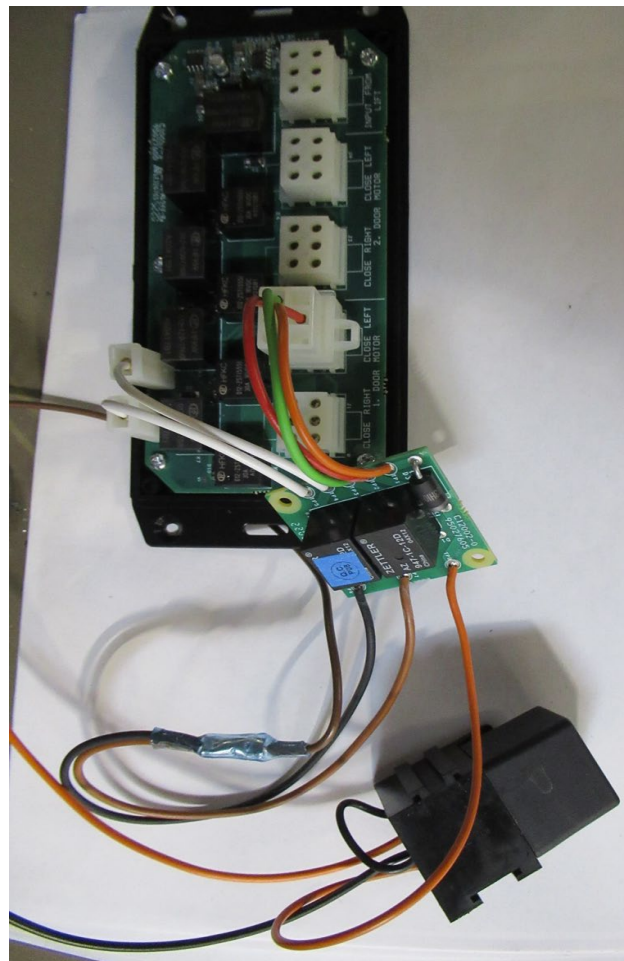
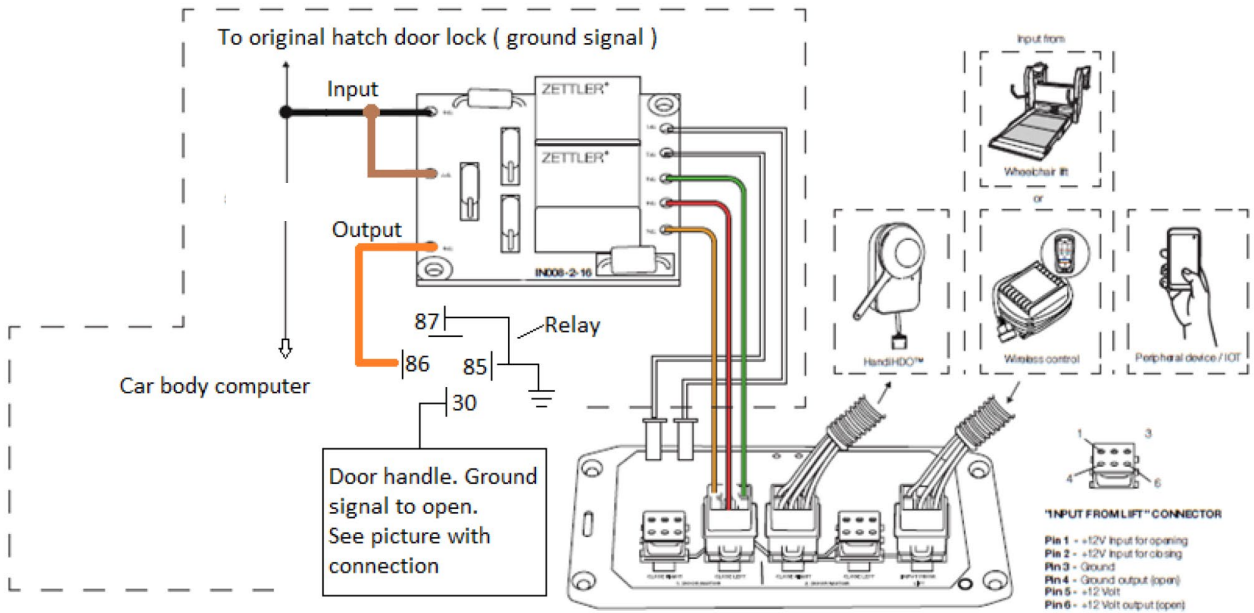

Door handle. Ground signal "input" pin 1 (Door release)

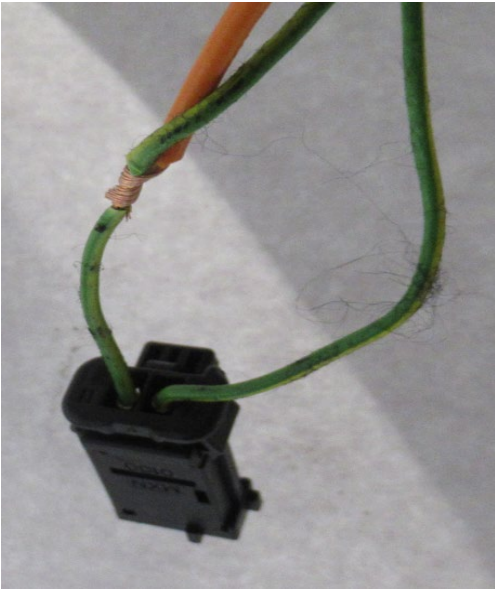

Door lock. Return signal pin 3 = Ground signal/door is open.

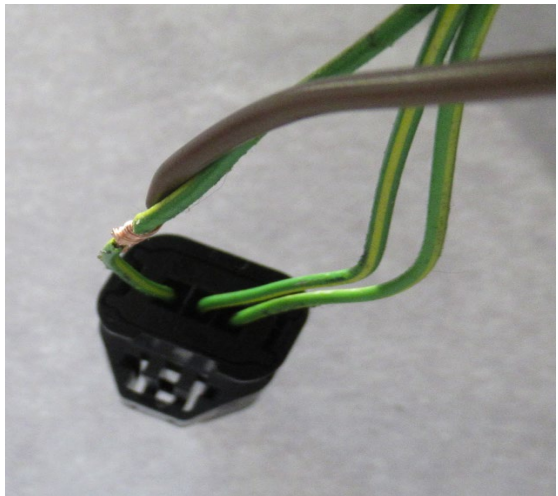



"INPUT FROM LIFT" CONNECTOR

- Pin 1 - +12V input for opening
- Pin 2 - +12V input for closing
- Pin 3 - Ground
- Pin 4 - Ground output (open)
- Pin 5 - +12 Volt
- Pin 6 - +12 Volt output (open)